



INSTALLATION INSTRUCTIONS

PART#: GMHD STAGE 1 & 2 LEVELING KIT

FITS: Chevrolet/GMC

•2011 - 2019 2500HD/3500HD



INSTRUCTIONS

SuspensionMAXX kits are designed to be easily installed and completely reversible to the factory supplied settings. These instructions are supplied for ease of installation, correct procedures and safety. Automotive experience recommended.

Thank you for choosing SuspensionMaxx for your vehicle. This kit is designed to add suspension travel and increase front and ground clearance. Specially designed tools and experience are required to complete the installation properly. These parts should only be installed by a qualified mechanic otherwise an unsafe vehicle and/or injury may result. Consult manufactures service manual for proper torque specifications and procedures. Instructions are supplied for the leveling kit installation only. Safety is important. Use safe working habits.

WARNING!

*This suspension system will enhance off road performance and increase ground clearance. **Larger tires will increase vehicle roll center height.** The vehicle will handle and respond to driver steering and braking differently from a stock factory equipped passenger car or truck. Extreme care must be used to prevent loss of control or vehicle rollover during abrupt maneuvers both on and off-road. Failure to operate this vehicle safely can result in vehicle damage, serious injury or death to the driver and passengers. **Always wear your seat belt and reduce your speed, avoid sharp turns, inclines and abrupt maneuvers.** Tread lightly, respect nature and enjoy the Off-Road Experience! Help keep it available for future generations.*









Thank You!
SuspensionMAXX Inc.

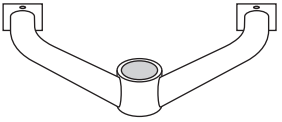

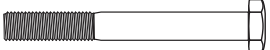

Again, Thank you for your purchase! Enjoy your SuspensionMAXX leveling system!

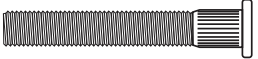
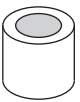
Questions? E-mail us at tech@suspensionmaxx.com or call 1.888.629.9226

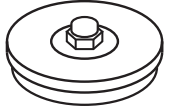
SMX-11HDUCA KIT

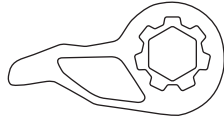
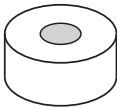
#	PART NAME	GRAPHIC FORM	QTY
A	Upper Control Arm Frame		2PC
B	“Bowtie” Differential Spacer		1PC
C	“M” Differential Spacer		1PC
D	“Round” Differential Spacer		1PC
E	Differential Spacer Extension Bolt		2PC
F	7/16 inch Differential Washer		2PC
G	Extra Heavy Skid Plate Spacer		4 PC
H	Splined Shock Absorber Studs		4PC
I	Shock Extension Spacers		4PC
J	12mm Strut Stud Lock Nuts		4PC
K	Ball Joint Plug		2PC

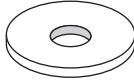
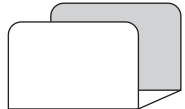
L	MAXXCam Torsion Key		2PC
M	Differential Spacer		4PC
N	14mm Differential Spacer Bolt		4PC
O	2 inch OD Differential Bolt Washer		4PC
P	MAXXCam Alignment Clip		1PC

QUICK START GUIDE

This Quick start guide is a basic overview of the install process; please refer to the install guide for detailed step by step instructions.

1. Unload torsion bars with torsion bar tool
2. Disconnect and remove front shocks
3. Disconnect ABS wires and brake lines from upper control arms.
4. Disconnect upper ball joints.
5. Remove Control arm upper cam bolts.
6. Install Upper control Arm.
7. Grease Upper Ball Joint and A-arm grease zerks
8. Install shocks with supplied shock extensions Bilstein 5100 or OEM length shocks
9. (excludes FOX 2.0 extended length front shocks)
10. Remove skid plate
11. Clearance differential center section housing against the cross member
12. Install lower diff spacers (Round , Bow Tie, W shaped spacers)
13. Install tall differential spacers between differential cross member and frame mount.
14. Install Maxx Cam torsion bar keys. A1 for 2.0”- 2.5” of lift & B1 for 3.0” of lift
15. Set Ride height and adjust torsion bar bolts- test drive and re- adjust as needed
16. Perform Wheel Alignment.

Again, Thank you for your purchase! Enjoy your SuspensionMAXX leveling system!

Questions? E-mail us at tech@suspensionmaxx.com or call 1.888.629.9226

PRELIMINARY STEPS

1. Remove torsion bar adjustment bolt with 21mm socket.
2. Unload torsion bars with torsion bar unloading tool and remove bridge nut.
3. Slide torsion bar forward, disengaging hex from lever.

CAUTION: Disengaging lever can fall from vehicle and cause injury.

NOTICE: Torsion bar may be frozen in lever, added force may be required for disassembly.

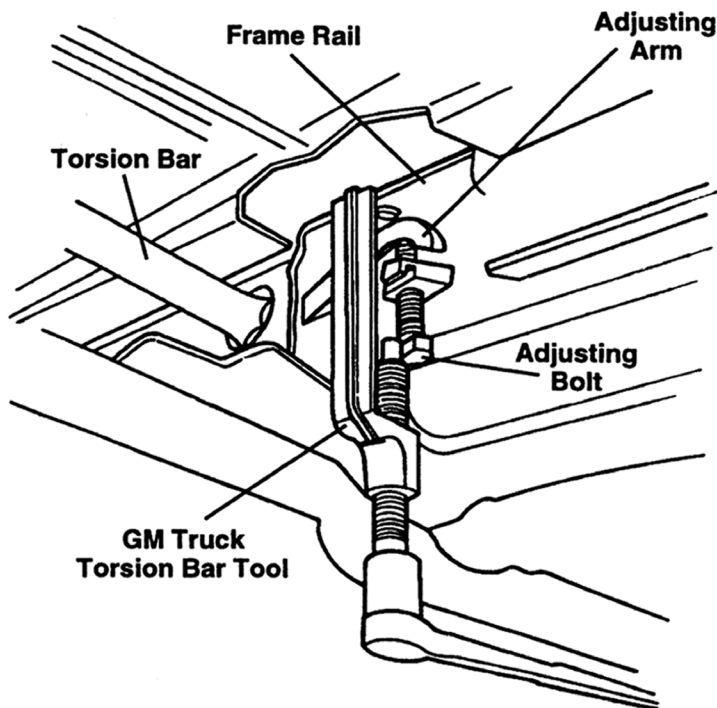

SECTION 1: Removal

1. Remove upper shock mount nuts using 18mm wrench and lower shock mounting hardware using 21mm wrench. Remove shock from vehicle .
2. Disconnect brake lines from frame. (10mm)
3. Disconnect ABS Wire clip from knuckle. (10mm)
4. Loosen upper ball joint nut with 18mm wrench 3-5 threads until an air gap is achieved and the nut spins freely. Strike the knuckle with a brass drift and hammer to shock the taper and unseat the ball joint. Then fully remove 18mm upper ball joint nut.

5. Using a Sharpie marker, mark the location of the cam bolt pin for ease of re-installation and proper alignment. Identify and note the position and location of front and rear cam bolts.
6. Using two 24mm wrenches, loosen and remove upper control arm cam mounting bolts.
7. Upper control arm should now be free to remove from vehicle.

STEP 2: Installation

1. Gently Guide new upper control arm into frame. **CAUTION:** Be careful to not damage control arm bushings in this process.
2. Reinsert and hand tighten cam bolts and realign marked cam location.
3. Swing upper control arm downwards and insert upper ball joint stud into knuckle.
4. Insert ball joint tapered stud to knuckle. Torque Castle nut to 50 Ft LBS Continue to tighten to next available slot. (NEVER back off the slotted nut to achieve alignment with the hole in the stud.) Install and spread cotter pin.
5. Torque upper Cam bolts to 150-170 Ft. LBS.

SECTION 2: Shock Relocation Kit Installation

NOTE: All stock length shock absorbers including Bilstein 5100 require shock extensions. Failing to use shock extensions will cause harsh ride and shock damage.

If your kit includes Fox Shocks, shock extensions are not required. Proceed to step 4

1. Remove upper and lower shock mounting hardware (21mm) Remove shock from vehicle .
2. Remove OE shock studs by supporting the shock by it's cross-pin and striking the stud out from the

Again, Thank you for your purchase! Enjoy your SuspensionMAXX leveling system!

Questions? E-mail us at tech@suspensionmaxx.com or call 1.888.629.9226

cross-pin.

(FIG 2-1)

3. Flip the shock over strike new studs into shock cross-pin.

(FIG 2-2)

4. Reinstall shock absorber with spacer sleeve on upper strut mount. (NOTE: Shock spacer sleeves not used with Fox Shocks.) Torque supplied nut to **50ft/lbs.**



5. Reinsert lower shock mount into place and insert 21mm bolt. Torque to 80 ft. lbs.
6. Reinstall wire loom clips onto exposed shock threads.
7. Repeat steps 1 through 4 for each side of the vehicle.

8. Reconnect brake lines and ABS wires.
9. Grease upper control arm bushing 2-3 pumps, and the upper control point 4-5 pumps or until boot is inflated. FIG. 3-4



10. Install tires and wheels.

SECTION 3: Differential Spacer

1. Remove skid plate to better access differential support mounting locations.
2. Use die grinder to remove excess material around mounts
3. Lightly jack and support the differential during the following steps.
4. Loosen (DO NOT REMOVE) the passenger side mounting bolts
This will aid with installation of spacers.
5. Remove driver side differential cross-member cradle.
6. Differential case will require slight modification to clear frame at the lowering height.

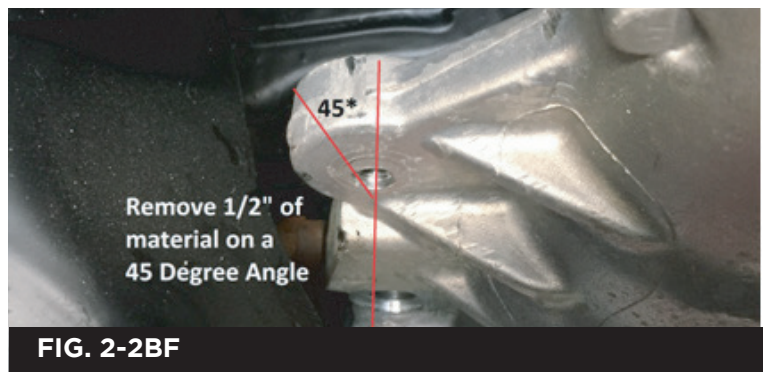

7. Align supplied spacers as shown in **FIG. 2-1**
8. Reinstall Mounts with supplied bolts. Note: reuse the rear mounting bolt. Be careful to install the longer of the 2 differential mounting bolts in the forward position.

FIG. 2-3

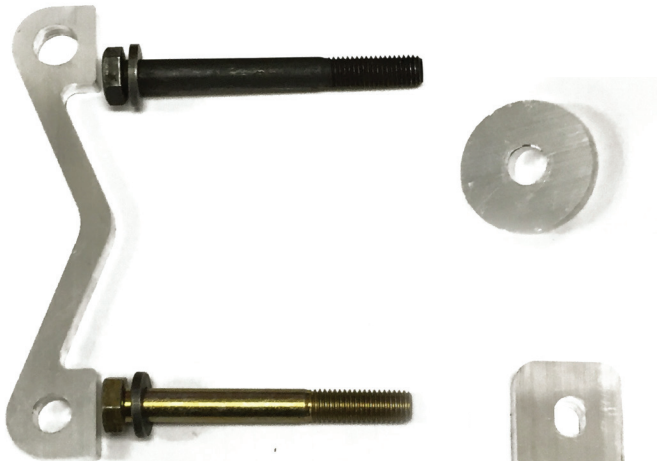

FIG. 2-3

9. 13. Install Passenger side differential spacer. Reuse stock hardware on Passenger side See **FIG. 2-4 & 2-5**
10. 14. Torque mounting nuts to 80Ft LBS.
11. 15. Install four 1" Diameter spacer on skid plate, reuse hardware. **FIG. 2-6**

FIG. 2-4



FIG. 2-5

NOTE: Use 7/16" gold washers to lower skid plate mounting position. **FIG 2-6**



FIG. 2-6

SECTION 4: Differential Cross-member Spacer

1. Support differential with suitable floor jack or stand.
2. Loosen four differential mounting bolts with 21mm socket. **DO NOT** remove at this time. Flex head ratchet is recommended for access to the top nut.
3. Remove one differential mounting bolt at a time.
4. Carefully lower the differential and install differential spacers one at a time.
5. Install new differential bolt with heavy duty washer. **DO NOT** tighten.
6. Repeat steps 3-5 on the remaining 3 differential bolts.
7. Tighten all four differential mounting bolts. Torque to **85ft/lbs**
NOTE: Tight clearance between differential and cross-member, centering of the differential may be required to keep proper clearance. Recentering or shifting of the differential may be required to maintain proper clearances.
8. Reinstall skid plate using 7/16" gold washers to add proper clearance between the differential and skid plate. Torque bolts to **20ft/lbs**

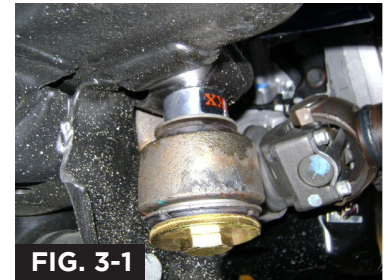

FIG. 3-1



FIG. 3-2

Again, Thank you for your purchase! Enjoy your SuspensionMAXX leveling system!

Questions? E-mail us at tech@suspensionmaxx.com or call 1.888.629.9226

SECTION 5: Calibration

NOTICE: Calibration is required before installation

1. To calibrate, match **A** or **B**, stamped on the internal hub, with the appropriate numbered outer position. Calibrate both MAXXCam torsion keys to the same position.
2. Apply anti-seize on gear tooth area to ease future disassembly.
3. Install hub alignment clip to aid in holding the **MAXXCam 7's** gear in place. (Only 1 supplied)
4. Reinstall **MAXXCam 7** in vehicle.
5. Remove hub alignment clip. (Discard - not required)
6. Adjust suspension ride height within specified range.

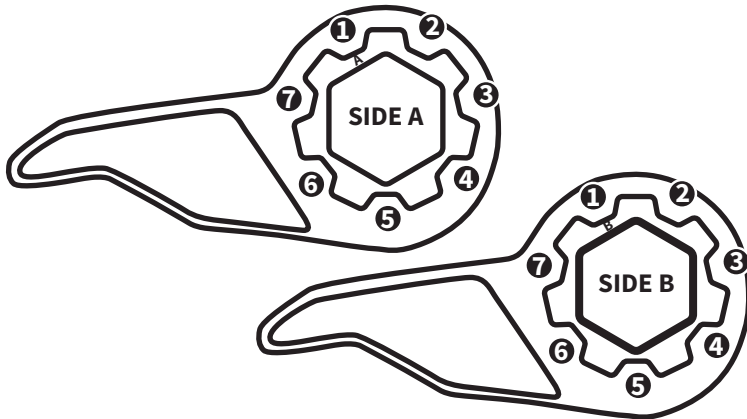

CALIBRATION CHART

Actual measurements may vary due to initial starting position, load and bar fatigue.

2011-2019 & Up Silverado HD & Sierra HD

ONLY RECOMMENDED WITH AFTERMARKET UPPER CONTROL ARMS

B1 = +2.5"

A1 = +1.7-2.5"

INCREASE B2 = +1.5"

DECREASE B3 = -1.5"

A3 = -2.5"

Record position for reference:

LEFT _____

RIGHT _____

INSTALLED ___/___/___

MILEAGE _____

NOTE: Lift heights shown on chart reflect the initial height achieved by the MAXXCam prior to adjustment of the torsion bar bolt. Results may vary.

This kit adds suspension travel only and will not add load carrying capacity to the suspension system.

DO NOT OVERLOAD

This kit can be over calibrated. Over adjustment of the torsion bar is not recommended!

NOTICE ALL POSITIONS MAY NOT BE USED IN SOME APPLICATIONS

NOTICE: WHEEL ALIGNMENT REQUIRED

WHEEL ALIGNMENT SPECS W/ LEVELING KIT

CAMBER 0.0Deg. +/- 0.5Deg.

CASTER 2.0Deg. +/- 1.0Deg.

(LEFT TO RIGHT MUST BE EQUAL +/- 0.25Deg.)

TOTAL TOE 1/8in. +/- 1/16in.

SECTION 6: Installation

1. Inspect torsion bars, cross-member support for cracks, rust or damage. Check adjusting bolts and nuts for damage, rust or stripped threads. Replace if necessary.
2. Calibrate MAXXCam 7 as needed to compensate for torsion bar sag and fatigue. **See Calibration Chart.**
3. Install MAXXCam 7 into cross-member, slide torsion bar rearward fully engaging torsion bar hex in MAXXCam 7.

NOTICE: A slight adjustment of torsion bar cross-member is required to clear MAXXCam 7 Leveling kit (FIG 5-1)

4. Reinstall torsion bar unloader tool. Increase tension on torsion bar unloader tool as required to reinsert bridge nut.

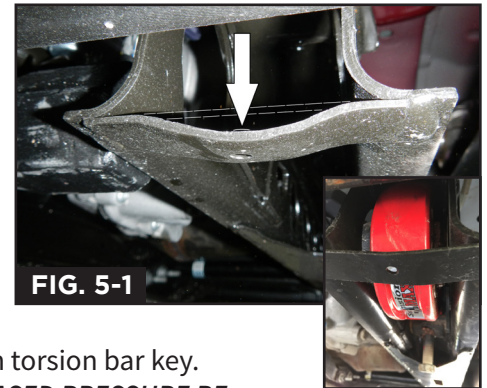

5. Reinstall torsion bar adjustment bolt, thread the bolt in until it makes contact with the MAXXCam torsion bar key.

WARNING: INCREASED PRESSURE REQUIRED! USE EXTREME CAUTION!

SECTION 7: Adjustments

1. With vehicle sitting on level ground on all four tires check and adjust ride height and be aware of upper control arm gap. As you adjust the torsion bar bolt the upper control arm gap will decrease. The gap must maintain 1/4" - 3/8" clearance between upper control arm and stop bracket. Adjust until ride height is adequate. Use the torsion bar adjustment bolts to balance ride height between both sides of the vehicle.

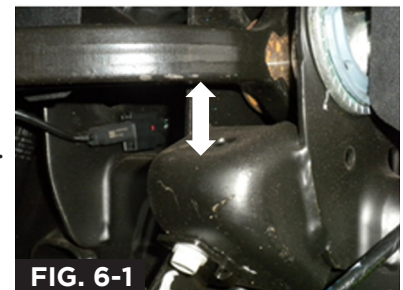

NOTICE: Over-adjustment will result in poor ride and difficulty setting the vehicles wheel alignment.

2. Check and adjust wheel alignment.

NOTICE: For best ride quality set ride height at 2.0" of lift, 26.5" center hub to fender opening. Stock 24.5" on most trucks. See (FIG 6-2)



Again, Thank you for your purchase! Enjoy your SuspensionMAXX leveling system!

Questions? E-mail us at tech@suspensionmaxx.com or call 1.888.629.9226